

2017 VAN STORAGE SOLUTIONS



UNMATCHED SECURITY & DURABILITY



WWW.WEATHERGUARD.COM



DESIGNED WITH THE PROFESSIONAL

WEATHER GUARD® Van Solutions are ready to roll with game changing improvements based on years of research and your input. Completely retooled shelving, improved bulkheads, customizable organizational features, and a host of smart new accessories, designed around the common sense idea that tools and equipment belong on the shelf, not the floor.

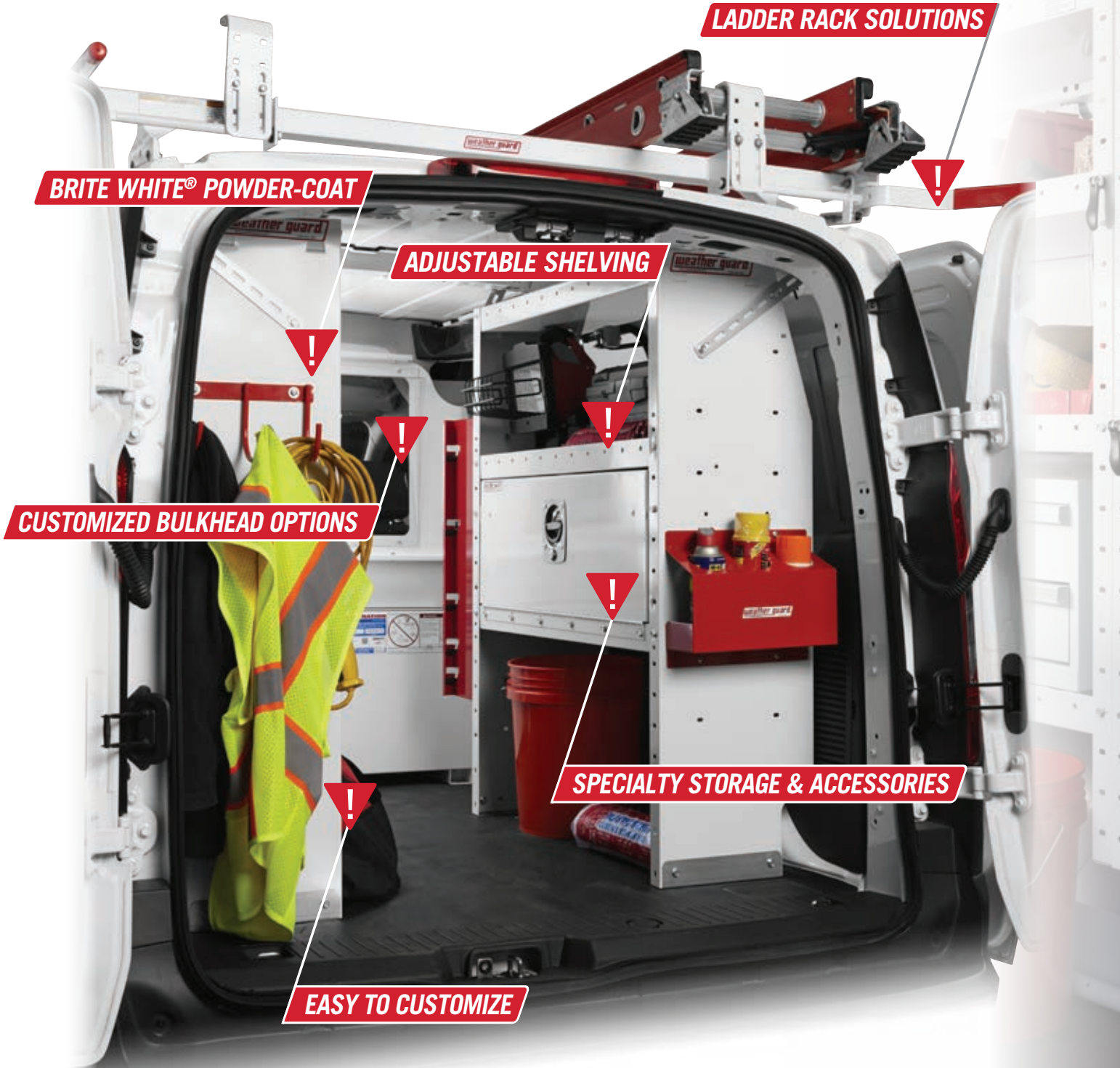

LADDER RACK SOLUTIONS

BRITE WHITE® POWDER-COAT

ADJUSTABLE SHELVING

CUSTOMIZED BULKHEAD OPTIONS

SPECIALTY STORAGE & ACCESSORIES

EASY TO CUSTOMIZE



TABLE OF CONTENTS

BULKHEADS	6
Bulkhead Accessories	6
Van Bulkheads	7
SHELVING	10
Adjustable Shelving	10
Shelving Accessories	11
Secure Storage	12
EZ Cube Welded Shelving	13
ACCESSORIES	14
REDZONE Accessories.....	14
Cabinets.....	15
Cab Command Center.....	16
Floor Mounted Accessories.....	17
Window Screens	18
Grab & Go Tool Cart	19
SPECIALTY STORAGE	20
PACK RAT® Drawer Units	20
ITEMIZER® Drawer Units	22
BED RAT® Sliding Platform	23
ROOF RACKS.....	24
EZGLIDE2™ Drop-Down Ladder Rack	24
Rack Accessories	25
Quick Clamp Aluminum Racks	26
All-Purpose Racks.....	28
Safari Rack.....	29
Sliding Ladder Rack.....	29
ROOF RACK FITTING GUIDE	30
PART NUMBER REFERENCE GUIDE.....	31



CUSTOM CONFIGURATION

The image shows a person's hands interacting with a laptop screen. The screen displays a web-based configuration tool for van storage solutions. At the top of the screen, there are two tabs: "PRO PACKAGES" and "STARTER PACKAGES". Below the tabs, the text "Select your package:" is followed by six options, each represented by a white van with a different storage configuration and a small inset image of the storage unit. The options are:

- Contractor/Remodeler FS
- Pumber/Plumbing Contractor FS
- Electrician/Electrical Engineer FS
- Telecom/Security FS
- WAC/Mechanical Contractor FS
- Basic/Delivery FS

The person's hands are positioned over the laptop keyboard and a yellow sticky note on a desk. In the background, there are blueprints and a green pencil. The overall scene suggests a professional setting where a van is being customized for a specific business need.

YOUR VAN, YOUR PLAN.

ATOR

CUSTOMIZING YOUR VEHICLE IS AS EASY AS 1-2-3:

1. Choose your make & model
2. Select a base package
3. Customize & add accessories

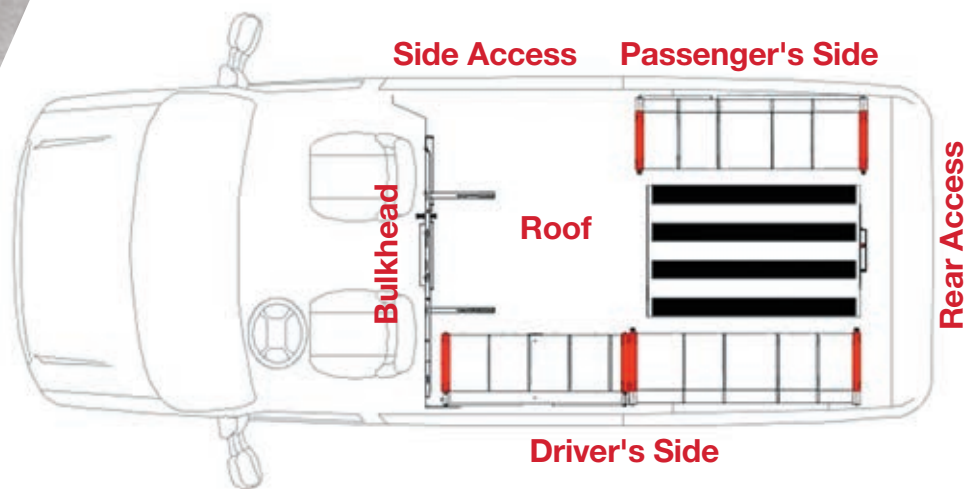

- Wide selection of vehicles with pre-built custom packages
- Printable design drawings and parts list
- Referral to local distributor for quote and installation

To get started, visit www.wgconfigurator.com

BULKHEADS

Our Full-Size, High-Roof, and Compact van bulkheads allow you to separate the driver compartment from the cargo area for maximum protection against shifting loads. Exclusive polycarbonate windows improve visibility and safety. Tighter panel design ensures cabin comfort, both noise and temperature. WEATHER GUARD® Bulkheads are available for all commercial van types and sizes, from high-roof to compact. Several bulkhead accessories are available to keep you organized.

EASY INSTALLATION

with sidewall and roof mounting brackets and pre-punched mounting holes for WEATHER GUARD® accessories

HEAVY GAUGE STEEL

is used for strength and durability

IMPROVED IMPACT RESISTANCE

protects you from loose objects in the cargo area



EXCLUSIVE 9" X 12" DOG HATCH™ DOOR

allows easy loading of long materials by utilizing the floor space in front of the bulkhead



POLYCARBONATE WINDOW BULKHEADS

allow for improved visibility, security and comfort

PROVIDES IMPROVED HEATING AND COOLING EFFICIENCY

in the passenger area, reduces noise level, too

NEW VERTICAL PANEL DESIGN

reduces ambient noise levels

OPTIONAL HINGE KIT

converts bulkhead to swing door version with lockable latch

WEATHER GUARD® EXCLUSIVE!



REDZONE ACCESSORIES FOR THE BULKHEAD

WEATHER GUARD® Bulkhead Accessories let you create a custom storage solution that securely organizes the items you need to locate quickly and easily.

Check out REDZONE Accessories, starting on page 14 for more details

Bulkhead Accessories*

MODEL	DESCRIPTION	WEIGHT
1 9879-7-01	Tool Organizer	3 lbs.
2 8875	Hard Hat Bracket	2 lbs.
3 8866	Fire Extinguisher	6 lbs.
4 8877-3	Practice Holder	4 lbs.
5 96901-3-01	Hinge Kit	4 lbs.
6 96903-3-01	Solid Panel Kit	10 lbs.



NOW AVAILABLE!

Deep offset bulkheads for Ford Transit provide extra legroom. Designated by a "D" at the end of the part number available only for the Ford Transit.



Model 96301-3-01

Model 96302-3-01



Model 96311-3-01

Model 96312-3-01

Low Roof Bulkhead for Transit Van



MODEL	DESCRIPTION	WEIGHT
96301-3-01	Window Bulkhead, Low Roof, Ford Transit	67 lbs.
96302-3-01	Screen Bulkhead, Low Roof, Ford Transit	67 lbs.
96301-3-01D	Deep Offset Window Bulkhead, Low Roof, Ford Transit	70 lbs.
96302-3-01D	Deep Offset Screen Bulkhead, Low Roof, Ford Transit	70 lbs.
96901-3-01	Swing Door Conversion kit with lockable latch	4 lbs.
96903-3-01	Solid Bulkhead Panel Adapter kit	10 lbs.

Mid Roof Bulkhead for Transit Van



MODEL	DESCRIPTION	WEIGHT
96311-3-01	Window Bulkhead, Mid Roof, Ford Transit	108 lbs.
96312-3-01	Screen Bulkhead, Mid Roof, Ford Transit	108 lbs.
96311-3-01D	Deep Offset Window Bulkhead, Mid Roof, Ford Transit	111 lbs.
96312-3-01D	Deep Offset Screen Bulkhead, Mid Roof, Ford Transit	111 lbs.
96903-3-01	Solid Bulkhead Panel Adapter kit for all full size Bulkheads	10 lbs.
96901-3-01	Swing Door Conversion kit with lockable latch	4 lbs.



Model 96321-3-01

Model 96322-3-01



Model 96111-3-02

Model 96511-3-02

High Roof Bulkhead for Transit Van



MODEL	DESCRIPTION	WEIGHT
96321-3-01	Window Bulkhead, High-Roof, Ford Transit	108 lbs.
96322-3-01	Screen Bulkhead, High-Roof, Ford Transit	108 lbs.
96321-3-01D	Deep Offset Window Bulkhead, High Roof, Ford Transit	111 lbs.
96322-3-01D	Deep Offset Screen Bulkhead, High Roof, Ford Transit	111 lbs.
96901-3-01	Swing Door Conversion Kit with lockable door latch	3 lbs.
96903-3-01	Solid Bulkhead Panel Adapter Kit	10 lbs.

Bulkhead for Transit Connect Van



Window bulkheads offer unobstructed visibility of the cargo area, side door, and rear door. Maximizes comfort in the passenger area. Lightweight mesh bulkheads deliver full driver and cargo protection.

MODEL	DESCRIPTION	WEIGHT
96511-3-02	Transit Connect Window Bulkhead**	40 lbs.
96111-3-02	Transit Connect Mesh Bulkhead	35 lbs.

See next page for Ford Econoline.

**Ford Transit Connect (2010 - 2013 model years) use -01 instead of -02



Bulkhead for Chevy, GM & Ford Econoline Full Size Vans

Offers improved visibility and a large area to mount accessories while providing safety and security for occupants and cargo.

MODEL	DESCRIPTION	WEIGHT
96101-3-01	Window Bulkhead	65 lbs.
96102-3-01	Screen Bulkhead	65 lbs.
96901-3-01	Swing Door Conversion kit with lockable latch (Hinge Kit)	4 lbs.
96903-3-01	Solid Bulkhead Panel Adapter kit	10 lbs.

Bulkhead for Compact Vans

Window bulkheads offer unobstructed visibility of the cargo area, side door, and rear door. Maximizes comfort in the passenger area. Lightweight mesh bulkheads deliver full driver and cargo protection.



MODEL	DESCRIPTION	WEIGHT
96514-3-01	Chevy City Express Window Bulkhead	40 lbs.
96114-3-01	Chevy City Express Mesh Bulkhead	35 lbs.



Bulkheads for Mercedes Sprinter and Metris Vans



Offers improved visibility and a large area for accessory mounts and holders while providing safety and security for occupants and cargo. Includes header panels for standard and high roof vans.

MODEL	DESCRIPTION	WEIGHT
96121-3-01	Sprinter Window Bulkhead	105 lbs.
96122-3-01	Sprinter Screen Bulkhead	105 lbs.
96513-3-01	Metris Screen Bulkhead	65 lbs
96113-3-01	Metris Screen Bulkhead	60 lbs
96901-3-01	Swing Door Conversion kit with lockable latch (Hinge Kit)	4 lbs.
96903-3-01	Solid Bulkhead panel adapter for all full or high roof bulkheads	10 lbs.
96513-3-01	Metris Window Bulkhead	xx lbs
96113-3-01	Metris Mesh Bulkhead	xx lbs



CUSTOM CONFIGURATOR





Bulkhead for Ram ProMaster® Standard & High Roof



Offers improved visibility and a large area for accessory mounts and holders while providing safety and security for occupants and cargo. Includes header panels for standard and high roof bans.

MODEL	DESCRIPTION	WEIGHT
96141-3-01	Ram ProMaster® Window Bulkhead	105 lbs.
96142-3-01	Ram ProMaster® Screen Bulkhead	105 lbs.
96901-3-01 (Hinge Kit)	Converts all full size or high roof bulkheads to swinging door with lockable door latch	4 lbs.
96903-3-01	Solid panel adapter kit for all full and high roof bulkheads	10 lbs.



Bulkhead for Nissan NV Standard & High Roof



Offers extensive rear and side visibility while providing occupant protection and cargo security.

MODEL	DESCRIPTION	WEIGHT
96201-3-01	Nissan NV Window Bulkhead <i>Includes extension panel for high roof vans.</i>	70 lbs.
96901-3-01 (Hinge Kit)	Swing Door Conversion kit with lockable latch for Nissan NV High Roof	4 lbs.
96903-3-01	Solid Bulkhead Panel Adapter kit	10 lbs.

Bulkhead for Nissan NV Standard & High Roof



Offers extensive rear and side visibility while providing occupant protection and cargo security.

MODEL	DESCRIPTION	WEIGHT
96114-3-01	Nissan NV200 Mesh Bulkhead	35 lbs.
96514-3-01	Nissan NV200 Window Bulkhead	40 lbs.

**CREATE A CUSTOM SOLUTION THAT FITS YOUR NEEDS.
IT'S EASY, FAST AND FLEXIBLE**

CUSTOMIZING YOUR VEHICLE IS AS EASY AS 1-2-3:

1. Choose your make & model
2. Select a base package
3. Customize & add accessories

ADJUSTABLE SHELVING

17° TAPERED END PANEL CLOSER FIT

for more working space inside the van



DEEP FULLY HEMMED SHELVES

sized for tools, equipment, and other materials



EASY TO CUSTOMIZE

with pre-punched mounting holes for WEATHER GUARD® accessories and cabinets

EASY TO ASSEMBLE AND INSTALL

with captive nuts on each shelf and complete installation hardware



ADJUSTABLE DIVIDERS

Includes pack of four adjustable dividers for each shelf

PUNCHED SHELVES

for easier installation of accessory cabinets

FRONT FLOOR CLEARANCE

(16" SHELVES ONLY)

for material storage.

Fits PACK RAT® Drawer Units

UNMATCHED DURABILITY

achieved with heavy duty 18 gauge steel construction

FLAT FRONTS

on 13½" deep adjustable shelves. Mount doors and accessories at floor level

WEATHER GUARD® EXCLUSIVE!



Shelf Units: Ships complete in one carton

MODEL	HEIGHT	WIDTH	DEPTH	SHELVES	DIVIDERS	WEIGHT
9333-3-03	34"	36"	13½"	2	8	48 lbs.
9334-3-03	34"	42"	13½"	2	8	48 lbs.
9335-3-03	34"	52"	13½"	2	8	72 lbs.
9336-3-03	34"	60"	13½"	2	8	70 lbs.
9343-3-03	44"	36"	16"	3	12	74 lbs.
9344-3-03	44"	42"	16"	3	12	80 lbs.
9345-3-03	44"	52"	16"	3	12	85 lbs.
9346-3-03	44"	60"	16"	3	12	104 lbs.
9353-3-03	44"	36"	13½"	3	8	53 lbs.
9354-3-03	44"	42"	13½"	3	8	57 lbs.
9355-3-03	44"	52"	13½"	3	8	66 lbs.
9356-3-03	44"	60"	13½"	3	8	73 lbs.
9363-3-03	60"	36"	16"	4	16	92 lbs.
9364-3-03	60"	42"	16"	4	16	94 lbs.
9365-3-03	60"	52"	16"	4	16	110 lbs.
9366-3-03	60"	60"	16"	4	16	136 lbs.
9373-3-03	60"	36"	13½"	4	12	76 lbs.
9374-3-03	60"	42"	13½"	4	12	94 lbs.
9375-3-03	60"	52"	13½"	4	12	110 lbs.
9376-3-03	60"	60"	13½"	4	12	136 lbs.

24" Deep Jumbo Shelving Items

Extra deep 24" shelving constructed of 18-gauge steel and finished with durable brite white powder coat. These shelves are easy to assemble and provide the perfect foundation for a customized van or trailer. Special order only, with longer lead times.



MODEL	HEIGHT	WIDTH	DEPTH	SHELVES
8393-3-01	59½"	42¼"	24"	3
8394-3-01	59½"	51¼"	24"	3
8395-3-01	59½"	69¼"	24"	3
8118-3-01	Short Bin Dividers for 24"D Shelves.			



SHELVING ACCESSORIES

1 Shelf Doors with High Security D Handle Lock

MODEL	HEIGHT	WIDTH	WEIGHT
9503-3-01	11"	36"	13 lbs.
9504-3-01	11"	42"	17 lbs.
9505-3-01	11"	52"	21 lbs.
9506-3-01	11"	60"	25 lbs.

2 Retainer Lips *keeps items in place under shelf units*

MODEL	HEIGHT	WIDTH	DEPTH	WEIGHT
9703-3-02	1½"	36"	1½"	1 lb.
9704-3-02	1½"	42"	1½"	1 lb.
9705-3-02	1½"	52"	1½"	2 lbs.
9706-3-02	1½"	60"	1½"	2 lbs.

Required to use Nissan NV Floor Mounting Points

Bin Sets *sturdy plastic bins sized to fit new van shelving*

MODEL	HEIGHT	WIDTH	DEPTH	BINS	WEIGHT
3 9854-7-01	5"	5½"	14¾"	9	1 lb.
4 9855-7-01	7"	8¾"	14¾"	6	1 lb.
5 9856-7-01	7"	16½"	14¾"	3	1 lb.
9858-7-01	5"	5½"	10.875"	9	8 lbs.
9859-7-01	7"	8¾"	10.875"	6	8 lbs.

Light Weight Shelf Back Panels

use with shelf doors to turn a shelf into a cabinet

MODEL	HEIGHT	WIDTH	WEIGHT
9603-3-02	7¾"	36"	2 lbs.
9604-3-02	7¾"	42"	3 lbs.
9605-3-02	7¾"	52"	4 lbs.
9606-3-02	7¾"	60"	5 lbs.
9603-3-01	14½"	36"	4 lbs.
9604-3-01	14½"	42"	6 lbs.
9605-3-01	14½"	52"	8 lbs.
9606-3-01	14½"	60"	10 lbs.

REDZONE Accessories *End panel and shelf*

MODEL	DESCRIPTION	WEIGHT
6 8866	Fire extinguisher	6 lbs.
7 8873-3-01	Extension cord brackets (3)	2 lbs.
8 8875	Hard hat bracket (<i>hat not included</i>)	2 lbs.
9832	Shelf mat, narrow	1 lb.
9 9836	Shelf mat, wide	1 lb.
10 9880-3-01	Literature holder	11 lbs.

End Panels *Can't find the shelf combination you need?*

Configure your own shelf system with end panels and accessory shelves.

MODEL	HEIGHT	WIDTH	DEPTH	WEIGHT
9203-3-01	36"	2"	13"	22 lbs.
9204-3-01	44"	2"	16"	30 lbs.
9206-3-01	60"	2"	16"	34 lbs.
9243-3-01	36"	2"	13½"	22 lbs.
9244-3-01	44"	2"	13½"	30 lbs.
9246-3-01	60"	2"	13½"	33 lbs.
9274-3-01	44"	2"	16"	30 lbs.
9276-3-01	60"	2"	16"	34 lbs.

Divider Sets *keep things on the shelf in place*

MODEL	HEIGHT	WIDTH	DIVIDERS	WEIGHT
9820	2"	10"	4	2 lbs.
9823	2"	13"	4	2 lbs.
9825	2"	13½"	4	2 lbs.
9826	2"	16"	4	2 lbs.

Shelf Center Support *Increase shelf load capacity with a set of center supports. One support included with each 60" wide shelf set.*

MODEL	HEIGHT	WIDTH	DEPTH	WEIGHT
9730-3-01	36"	1.2"	1.2"	7 lbs.
9740-3-01	46"	1.2"	1.2"	9 lbs.
9760-3-01	62"	1.2"	1.2"	12 lbs.

Quick Adjust Handle Kit *Includes handles and pins for fast, toolless adjustability*

MODEL	WEIGHT
70202	0.2 lbs.

Nissan Mounting Kits *required to use Nissan floor mounts*

MODEL	HEIGHT	WIDTH	DEPTH	WEIGHT
9720-3-01	3"	10"	2"	1 lb.

Extra Shelves *Includes one set of dividers*

MODEL	HEIGHT	WIDTH	DEPTH	WEIGHT
9133-3-01	2"	36"	13"	14 lbs.
9134-3-01	2"	42"	13"	18 lbs.
9135-3-01	2"	52"	13"	22 lbs.
9136-3-01	2"	60"	13"	26 lbs.
9143-3-01	2"	36"	13½"	14 lbs.
9144-3-01	2"	42"	13½"	18 lbs.
9145-3-01	2"	52"	13½"	22 lbs.
9146-3-01	2"	60"	13½"	26 lbs.
9163-3-01	2"	36"	16	16 lbs.
9164-3-01	2"	42"	16	20 lbs.
9165-3-01	2"	52"	16	24 lbs.
9166-3-01	2"	60"	16	28 lbs.

SECURE STORAGE

Add extra security and theft-resistance for valuable tools and equipment with WEATHER GUARD® Secure Storage shelf units. Multiple door and drawer modules easily assemble into REDZONE Shelving. Our welded steel construction and heavy-duty locking mechanism ensures peace of mind on the job or in the parking lot.

- ! HIGH SECURITY**
welded steel box and shelf construction
- ! UNMATCHED ORGANIZATION & EFFICIENCY**
with no wasted space below or between drawers
- ! UNMATCHED DURABILITY**
box construction strengthens and rigidizes shelf unit
- ! EXTRA LARGE STEEL DRAWERS**
17"x14"x4" or 6" with ball bearing slides rated at 75 pounds per drawer
- ! FAST AND EASY ASSEMBLY**
modules bolt to end panels. Add top shelf to complete unit.
- ! FULLY FUNCTIONAL 16" SECURE MODULE TOP**
designed like a 16" shelf for additional storage

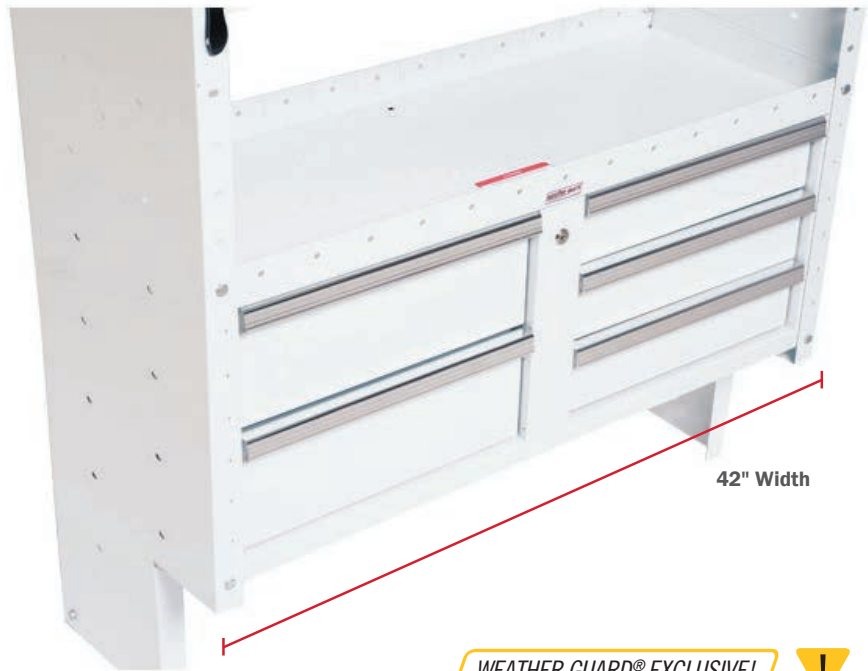

WEATHER GUARD® EXCLUSIVE!



Select the shelf unit to fit your van, then the storage module to fit your needs.

Secure Storage Shelf Units (42" Wide)

	MODEL	HEIGHT	DIVIDERS	WEIGHT
1	Full Size Vans			
	9381-3-03	44"	8	104 lbs.
	Includes end panels and top shelf for secure storage unit			
2	High Roof Vans			
	9391-3-03	60"	12	108 lbs.
	Includes end panels, top and center shelf for secure storage unit			
3	Storage Module Only (for 42" wide shelf units) ORDER SEPARATELY			
	9040-3-01	Door Module		47 lbs.
	9045-3-02	5 Drawer Module		78 lbs.

Secure Storage Service Parts xx- Designates key code Specify key code 11-20 when ordering

MODEL	DESCRIPTION	WEIGHT
70206-xx	Replacement Lock Kit	117 lbs.
70210-xx	Key Kit	1 lb.
70211-xx	Replacement D Handle Kit	1 lb.



Door Module
9040-3-01



5 Drawer
Module
9045-3-02



EZ-CUBE WELDED SHELVING

Heavy-duty van storage, made easy. Our fully arc-welded WEATHER GUARD® EZ-Cube Shelving is pre-assembled and ready to install. Pre-punched shelves allow for quick installation of cabinets, bin dividers, or accessory doors. Heavy-gauge steel construction with our signature bright white powder coat ensure years of durability, and a professional appearance.

TAPERED END PANEL DESIGN

allows a close fit to the van wall and additional cargo space in the middle of the van

FULLY ARC WELDED

for durable construction and no assembly

HEMMED SHELVES

provide extra strength and a lip in front of the shelf for load retention

BOTTOM SHELF IS PRE-PUNCHED

for EZ installation of accessory cabinets on page 30



MIDDLE TWO SHELVES ARE PRE-PUNCHED

for EZ Bin Dividers

BOTTOM RETAINER LIP

is made of durable, heavy gauge steel

EZ SHELF DOORS

turns bottom shelf into a cabinet



EZ Bin Dividers mount to two middle shelves

SHELVING

EZ-Cube for Full-Size Vans

MODEL	SHELVES	HEIGHT	WIDTH	TOP DEPTH	BOTTOM DEPTH	WEIGHT
9400-3-01	4	43¾"	42"	11¼"	13¾"	76 lbs.
9452-3-01	4	43¾"	51"	11¼"	13¾"	90 lbs.

Accessories for EZ-Cube Shelving

MODEL	DESCRIPTION	WEIGHT
8401-3-01	EZ Bin Dividers (8)	18 lbs.
8841	EZ Shelf Mat (trim to fit)	1 lb.
8502-3-01	EZ Shelf door, 42" wide, 10" high	17 lbs.
8503-3-01	EZ Shelf Door, 51" wide, 10" high	20 lbs.

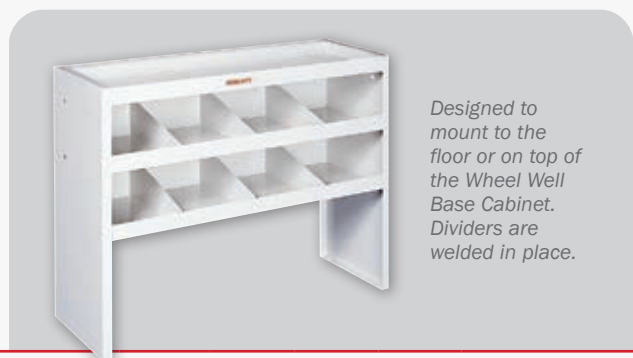

Designed to mount to the floor or on top of the Wheel Well Base Cabinet. Dividers are welded in place.

Welded Stack Unit

MODEL	SHELVES	HEIGHT	WIDTH	DEPTH	DIVIDERS	WEIGHT
8230-3-01	3	30"	36"	12"	6	25 lbs.



Designed to fit over the wheel well and provide a flat, sturdy foundation for Shelf Units, Parts Cabinets, or Drawer Units.

Wheel Well Base Cabinet

MODEL	HEIGHT	WIDTH	DEPTH	WEIGHT
9444-3-01	13¾"	42¾"	15"	49 lbs.

REDZONE ACCESSORIES

Looking for parts and supplies won't slow you down with new and re-engineered REDZONE van storage accessories. Organizers and holders keep frequently used items in easy reach for maximum productivity. Tool cabinets, parts bin boxes, and locking storage keep small components organized.

CUSTOMIZED ORGANIZATION

for supplies and tools

HEAVY DUTY 18 GAUGE STEEL CONSTRUCTION

makes for tough, long lasting accessories

POWDER COAT FINISH

provides durability

EASY TO INSTALL

to shelf end panels, bulkheads, and door



HOOKS AND BRACKETS

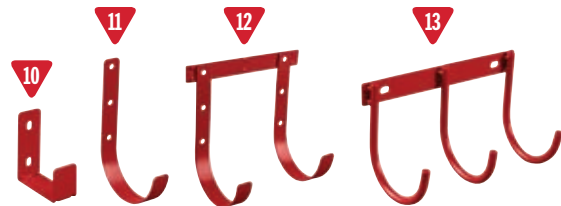

BUCKET AND TANK HOLDERS



REDZONE Accessories

	MODEL	DESCRIPTION	HEIGHT	WIDTH	DEPTH	WEIGHT
1	9874-7-01	Can Organizer	9.8	12	4	3
2	9878-7-01	Cleaning Station	15.5	13	7	10
3	9879-7-01	Tool Organizer	5.5	15	4	3
4	9881-7-01	Caulk Tube Tray	7.5	13.5	7.5	4.25
5	9882-7-01	Wire Spool Holder End Mount	26	14	6	12
6	9883-7-01	Large Parts Bin	11	13	7	10
7	9884-7-01	Medium Parts Bin	6.5	13	7	8
8	9885-7-01	5 Gallon Bucket Holder	6.25	11.25	11.25	8
9	9886-7-01	30# Refrigerant Tank Holder	10.75	9.75	9.75	9
10	9887-7-01	Ladder Holder	4	1.5	3.5	0.25
11	9891-7-01	Large Hook (5" Dia)	8	1.1.25	5	0.5
12	9892-7-01	2 Hook Holder (5" Dia)	8	9	5	0.5
13	9893-7-01	3 Hook Cord Or Tool Holder	5.25	9	4.5	0.5

CABINETS

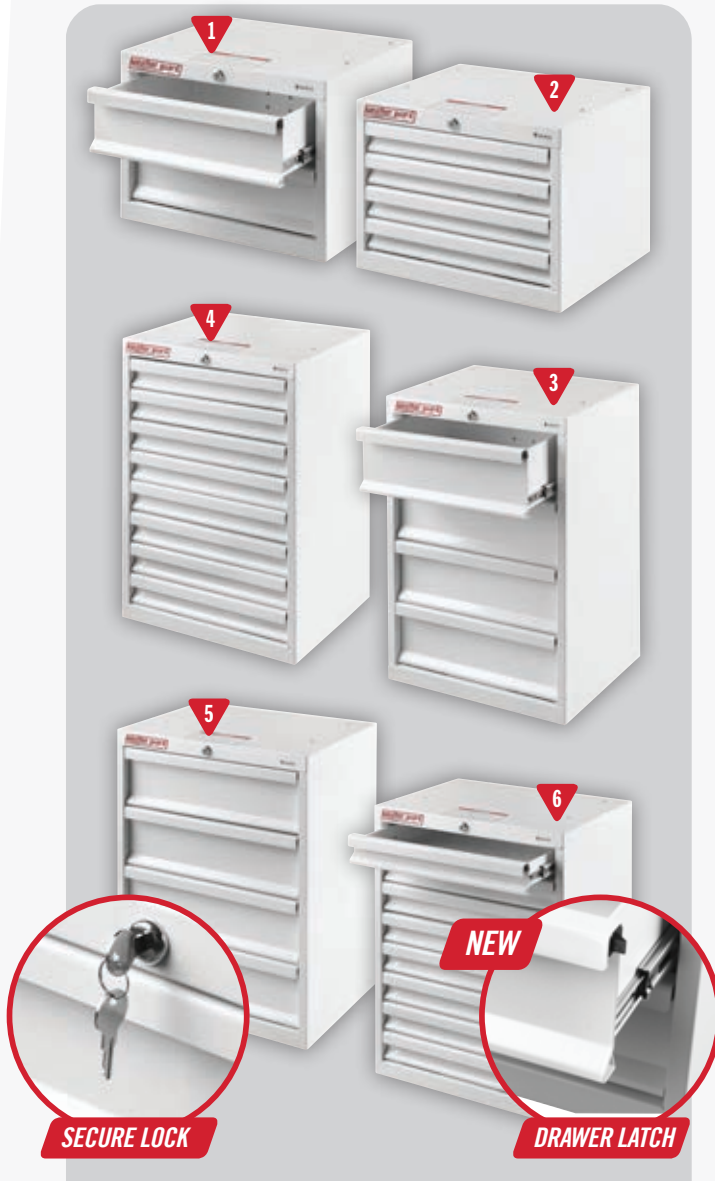

Mechanics Grade Tool Cabinets

High quality and durable mechanics grade tool cabinets for your van feature easy-to-grip handles and smooth ball-bearing rollers.

	MODEL	DRAWERS	HEIGHT	WIDTH	DEPTH	WEIGHT
1	9912-3-02	2	12"	16"	13.7"	26 lbs.
2	9914-3-02	4	12"	16"	13.7"	32 lbs.
3	9924-3-02	4	24"	16"	13.7"	48 lbs.
4	9928-3-02	8	24"	16"	13.7"	60 lbs.
5	9984-3-01	4	24"	18"	13.7"	53 lbs.
6	9988-3-01	8	24"	18"	13.7"	60 lbs.

High quality, durable Drawer Cabinets feature latches for each drawer, smooth ball-bearing rollers, and secure locks that can be keyed alike. Bin Cabinets feature hook and loop fasteners to securely hold bins in place.

Cabinet Divider Kits

MODEL	DESCRIPTION	WEIGHT
9822-3-01	Divider and liner kit for 9914-3-02, 9928-3-02	2 lbs.
9824-3-01	Divider and liner kit for 9912-3-02, 9924-3-02	2 lbs.



Parts Boxes & Bin Cabinets

	MODEL	BINS	HEIGHT	WIDTH	DEPTH	WEIGHT
1	9906-3-02	6	4½"	32½"	11¾"	18 lbs.
2	9909-3-02	9	12"	17"	11¾"	28 lbs.
3	9918-3-02	18	12"	32½"	11¾"	54 lbs.
4	9950-7-02*	N/A	12.6"	20.3"	14.4"	4 lbs.
5	9951-9-01	N/A	3"	18½"	13"	3 lbs.
Special Order Cabinets (Call for availability. Longer lead time required)						
6	8908-3	8	8½"	22 "	11¾"	24 lbs.
7	8931-3*		15¾"	21¾"	12¾"	28 lbs.

*Parts cases not included

NEW! Improved Cabinet Accessory Mounting

The new van shelf design includes cabinet mounting holes that make it easier to assemble and install. There are two fast ways to mount cabinets and parts boxes to van shelves.



1 Invert shelf when assembling it and mount cabinet directly to shelf.

2 Keep shelf facing up and use Cabinet Mounting Spacer kit Model 9994.

MODEL	DESCRIPTION	WEIGHT
9994	Cabinet Mounting Spacer Kit	1 lb.
9996-3-01	Mounting bracket kit for 16" shelves	1 lb.

CAB COMMAND CENTER ⚠

WEATHER GUARD® EXCLUSIVE! ⚠

Rethought and repurposed. Not a file box, but a between-seat Cab Command Center! Plenty of room for your laptop and hanging files. Handy clip board on lid and extra storage for personal items. Power Pass® electrical pass-thru grommet lets you keep everything charged while you're on the road. Our D-Handle lock keeps everything safe when you're on the job. Easy to release interior latch lets you take it when you need it. Use Model 9010-3-01 for Ford Transit, Ram ProMaster® vans & Model 9012-3-01 for Sprinter, GM and Ford E-Series vans.

SECURE D HANDLE LOCKS

single point latching for theft-resistance

HIDDEN LATCH TO BASE ⚠

means only you can remove it from your vehicle

SIMPLIFIED INSTALLATION

gets you back on the job quickly

RAISED MOUNTING BASE FOR 6" FLOOR CLEARANCE

with tamper-resistant Torx® head mounting bolts

POWER PASS® ELECTRICAL PASS-THRU GROMMET ⚠

allows you to charge items within the box



Cab Command Center

MODEL	HEIGHT	WIDTH	DEPTH	WEIGHT
1 9010-3-01	18"	7½"	20"	30 lbs.
for Ford Transit and RAM Promaster				
2 9012-3-01	12"	13"	20"	30 lbs.
for Sprinter, Chevrolet Express, GMC Savana, and Ford E-series				



Door Trays and Literature Holders

MODEL	HEIGHT	WIDTH	WEIGHT
1 9871-3-01	21¾"	20¼"	19 lbs.
2 9872-3-01	21¾"	20¼"	18 lbs.
3 9873-3-01	21¾"	20¼"	19 lbs.

MODEL	BINS	HEIGHT	WIDTH	DEPTH	WEIGHT
4 9880-3-01	6	15"	13"	4¾"	11 lbs.

These door organizers keep tools and supplies close by. No digging around inside the van for those items used on every job. Durable steel trays and lids keep everything in place while driving. Adjustable dividers let you customize.

You not only build or repair, but educate and inform customers. Catalog and literature holders keep information at hand, for your customers or crews.



Locking Storage & CATV Cabinets

	MODEL	SHELVES	HEIGHT	WIDTH	DEPTH	WEIGHT
1	9020-3-01	N/A	22"	18"	16"	25 lbs.
2	9021-3-01	2*	22"	18"	16"	35 lbs.
3	9029-3-01	N/A	22"	18"	16"	25 lbs.

*Removable Shelves

Great for securing electronics or expensive equipment. Our new locking storage cabinets feature secure locking D-Handles and tool-less reversible doors.

9029-3-01 is an open base unit with a handy storage bin.



Floor Mounted Accessories

	MODEL	DESCRIPTION	HEIGHT	WIDTH	DEPTH	WEIGHT
1	9861-3-01	Cable spool holder	42½"	19¾"	16¼"	37 lbs.
2	9862-3-01	3 - 50 lb. tank holder	45½"	15½"	8"	31 lbs.
3	9863-3-01	2 - 30 lb., 1 - 50 lb. tank holder	40"	15½"	8"	27 lbs.
4	9864-3-01	4 - 30 lb. tank holder	48½"	13"	8"	31 lbs.
5	9860-3-01	Catalog file unit	36"	6"	12"	16 lbs.
	9866-3-01	Three spool cable holder	42½"	19¾"	16¼"	37 lbs.

You're a professional, a specialist. You need specific equipment to keep at the top of your game. WEATHER GUARD® Van Solutions has what you need. Tank and cable racks, and work tops.



Specialty Equipment

	MODEL	DESCRIPTION	HEIGHT	WIDTH	DEPTH	WEIGHT
1	9444-3-01	Wheel Well Cabinet	13¾"	42¾"	15"	9 lbs.
2	9912-3-01	2 Drawer Cabinet	12"	16"	13.7"	26 lbs.
3	9914-3-01	2 Drawer Cabinet	12"	16"	13.7"	32 lbs.
4	8867-3-01	Steel work top	1½"	42"	18"	6 lbs.

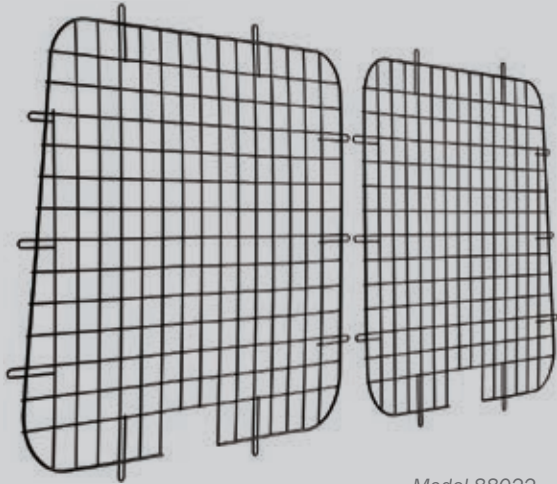

Model 88022

Window Screens

MODEL	VAN TYPE	QUANT.	DESCRIPTION	WEIGHT
88021	'92 & Newer Full-size Ford	2	Side Door - Hinged	8 lbs.
88022	'92 & Newer Full-size Ford	2	Rear Door - Hinged	8 lbs.
88023	'92 & Newer Full-size Ford	1	Side Door - Sliding	8 lbs.
88026	'96 & Newer Full-size GM	2	Side Door - Sliding	8 lbs.
88027	'96 & Newer Full-size GM	2	Side Door - Hinged	7 lbs.
88028	'96 & Newer Full-size GM	2	Rear Door - Hinged	8 lbs.
88040	'07 & Newer Dodge Sprinter	1	Side Door	7 lbs.
88041	'07 & Newer Dodge Sprinter	2	Rear Door	9 lbs.
88042	'08 & Newer Dodge RAM CV	2	Side Door - Sliding	6 lbs.
88043	'08 & Newer Dodge RAM CV	2	Rear Side Windows	7 lbs.
88044	'09 Dodge RAM CV	1	Rear Door - Hatch	6 lbs.
88045	'10 Ford Transit Connect	2	Rear Door	7 lbs.
88046	'10 Ford Transit Connect	2	Side Door	9 lbs.
88047	'10 Ford Transit Connect	2	Side Rear Window	7 lbs.
88050	Ram ProMaster®	2	Rear Door	9 lbs.
88051	Ram ProMaster®	1	Side Door	7 lbs.
88052	Ram ProMaster®	1	Side, Fixed	7 lbs.
88060	Ford Transit Low Roof	2	Rear Door	8 lbs.
88061	Ford Transit Low Roof	1	Side Door - Sliding	8 lbs.
88062	Ford Transit Mid and High Roof	2	Rear Door	9 lbs.
88063	Ford Transit Mid and High Roof	1	Side Door	9 lbs.
88064	Ford Transit Low Roof	2	Side Door - Hinged	8 lbs.



Model 89015

Van Floor Mats

MODEL	VAN TYPE	WEIGHT
89011	70" x 124" rectangular, must be cut to fit any style vans	55 lbs.
89015	'96 & newer GM 135" wheel base	55 lbs.
89017	'92 & newer Ford standard wheel base	60 lbs.
89020	'14 & newer Ram ProMaster®, 118" wheelbase	32 lbs.
89021	'14 & newer Ram ProMaster®, 136" wheelbase	39 lbs.
89022	'14 & newer Ram ProMaster®, 158" wheelbase	46 lbs.
89023	'14 & newer Ram ProMaster®, 158" extended wheelbase	49 lbs.
89024	'15 & newer Ford Transit, 130" wheelbase	45 lbs.
89025	'15 & newer Ford Transit, 148" wheelbase	50 lbs.
89026	'15 & newer Ford Transit, 148" extended wheelbase	55 lbs.

Designed to cover seating wells in the van floor. Required when installing bulkhead units and other equipment.



High-security box for the inside of a van that features ¼" plate steel around the lid opening and the WATCHMAN® IV Lock System.

Strong Box

MODEL	HEIGHT	WIDTH	DEPTH	WEIGHT
9036-3	16"	36¾"	19¾"	93 lbs.

WEATHER GUARD® EXCLUSIVE!



GRAB & GO TOOL CART

Our new, modular 3-piece rolling tool chest puts those tools and parts used on every job at your fingertips. Heavy-duty construction keeps your productivity rolling for years to come.

- Modular, 3-piece rolling tool chest
- Removable tool box with steel tray
- Sliding drawer unit
- Tilt-out storage bin
- Telescoping handle



Grab & Go Tool Cart

MODEL	HEIGHT	WIDTH	DEPTH	BOXES	WEIGHT
9953-7-01	28½"	20"	12"	3	24 lbs.

Select one of our pre-configured Van Storage Solutions below. You can add to or change items in these packages later in the process.

Select the package level:

PRO PACKAGES STARTER PACKAGES

Select your package:

Contractor/Remodeler FS

Plumber/Plumbing Contractor FS

Electrician/Electrical Engineer FS

HWAC/Mechanical Contractor FS

Basic Delivery FS

Telecom/Security FS

weather guard

CUSTOM CONFIGURATOR

CUSTOMIZING YOUR VEHICLE IS AS EASY AS 1-2-3:

1. Choose your make & model
2. Select a base package
3. Customize & add accessories

ACCESSORIES

PACK RAT[®] DRAWER UNITS

Have your equipment waiting for you as soon as you open the door. These heavy-duty pull-out drawer units can be mounted inside the side or rear door openings. They offer easy access to hundreds of pounds of tools and supplies, while leaving floor space open for hauling materials or moving in and out of the vehicle.



INTRODUCING OUR NEW PACK RAT[®] DRAWER UNIT FOR POWER TOOLS



ONE-TOUCH RED PUSHBUTTON LATCH ASSEMBLY

allows for one hand operation

HEAVY GAUGE ALUMINUM

*is strong, but light, with a
225 pound load rating*

SMOOTH ROLLING DRAWER

for easy access and organization

ANTI-SKID STRIPS

*provide traction for
wet and muddy boots*

EASY MAINTENANCE

*drawers are completely
removable to clean,
lubricate, and service*



POWER PASS[®] ELECTRICAL PASS-THRU GROMMET

for tool charging



Model 310-3-01

WEATHER GUARD[®] EXCLUSIVE!



14-GAUGE STEEL

*on top and sides allows for a 750 lb. load
rating when evenly distributed on top of unit*

12-GAUGE STEEL SKIDS

*and full width ribs underneath and inside
the unit add extra strength*

SMOOTH ROLLING DRAWER

*provides trouble free operation and
handles up to 425 lbs. of equipment*





**Drawer
Compartment**
14½" H x 11¾" W
x 39" L

Model 310-3-01

NEW Tool Drawer

MODEL	HEIGHT	WIDTH	DEPTH	COMPARTMENTS	WEIGHT
310-3-01	17¾"	12¼"	42"	1	56 lbs.

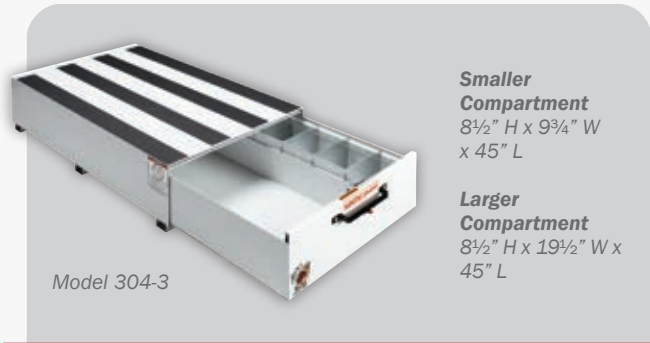

**Smaller
Compartment**
8½" H x 9¾" W
x 45" L

**Larger
Compartment**
8½" H x 19½" W x
45" L

Model 304-3

Extra Wide Compartment 48" Long Drawer Unit

MODEL	HEIGHT	WIDTH	COMPARTMENTS	DIVIDERS	WEIGHT
304-3	9½"	30"	2	6	220 lbs.
334-3	13"	30"	2	6	245 lbs.



Each Drawer
Compartment
Measures 5" H
x 9¾" W x 21" L

Model 312-3-01

9½" High, 24" Long Drawer Unit

MODEL	WIDTH	COMPARTMENTS	DIVIDERS	WEIGHT
312-3	30"	3	12	151 lbs.



Model 301-3

Model 303-3

Each Drawer
Compartment
Measures 8½" H x
9¾" W x 21" L

13" High, 24" Long Drawer Units

MODEL	WIDTH	COMPARTMENTS	DIVIDERS	WEIGHT
301-3	30"	3	12	169 lbs.
303-3	39¾"	4	12	217 lbs.

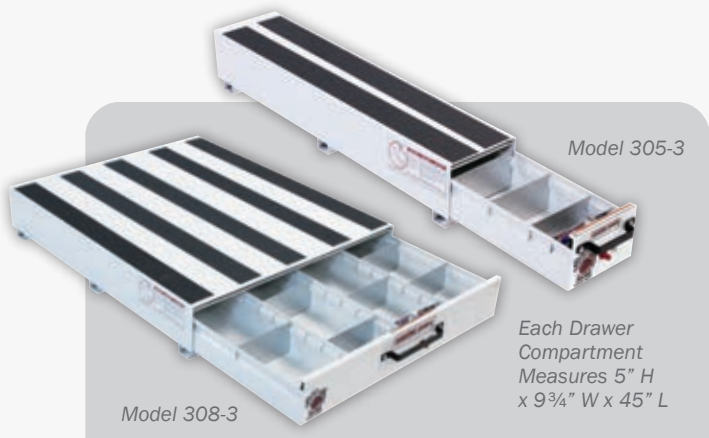

Model 305-3

Model 308-3

Each Drawer
Compartment
Measures 5" H
x 9¾" W x 45" L

9½" High, 48" Long Drawer Units

MODEL	WIDTH	COMPARTMENTS	DIVIDERS	WEIGHT
305-3	10¼"	1	6	106 lbs.
306-3	20"	2	12	179 lbs.
307-3	30"	3	18	247 lbs.
308-3 (white)	39¾"	4	24	322 lbs.
308-5 (black)	39¾"	4	24	322 lbs.



Model 335-3

Model 336-3

Each Drawer
Compartment
Measures 8½" H x
9¾" W x 45" L

13" High, 48" Long Drawer Units

MODEL	WIDTH	COMPARTMENTS	DIVIDERS	WEIGHT
335-3	10¼"	1	6	130 lbs.
336-3	20"	2	12	210 lbs.
337-3	30"	3	18	294 lbs.
338-3 (white)	39¾"	4	24	383 lbs.
338-5 (black)	39¾"	4	24	383 lbs.

SPECIALTY STORAGE

ITEMIZER® DRAWER UNITS

This exclusive, lightweight aluminum storage solution conveniently increases your storage space by placing small equipment at your fingertips without the need to crawl inside the van. Drawer dividers provide an extensive array of organizing options.

LIGHTWEIGHT ALUMINUM DRAWERS
carry up to 75 lbs. of equipment each

UNITS CAN BE STACKED
as needed for additional storage

ROLLER MOUNTED DRAWERS
glide open to full extension

ADJUSTABLE DRAWER DIVIDERS
offer greater flexibility



Model 318-3

ANTI-SKID STRIPS
provides traction for wet and muddy boots

LOCK MOUNT
is provided for installation of optional camlock

Model 314-3
1 Drawer

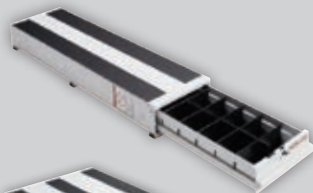

Model 316-3
2 Drawer Lateral



Model 317-3
3 Drawer Lateral

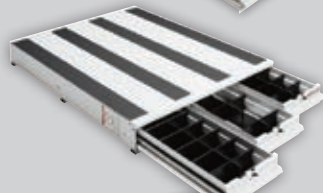

Model 318-3
4 Drawer Lateral



Each Drawer
Compartment Measures
4¼" H x 10½" W x 46½" L

Model 326-3
2 Drawer Stacked

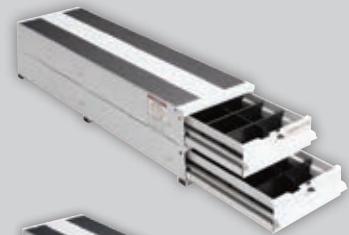

Model 327-3
3 Drawer Stacked

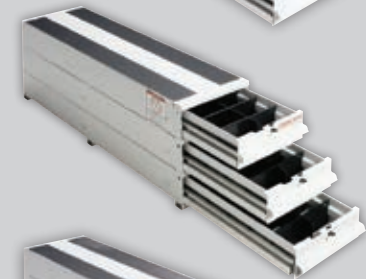

Model 328-3
4 Drawer Stacked



Each Drawer Compartment
Measures 4¼" H x 10½" W x 46½" L

Lateral Drawer Units

MODEL	DRAWERS	HEIGHT	WIDTH	DEPTH	WEIGHT
314-3	1	6¾"	12¼"	49"	26 lbs.
316-3	2 Lateral	6¾"	24"	49"	55 lbs.
317-3	3 Lateral	6¾"	36"	49"	85 lbs.
318-3	4 Lateral	6¾"	48"	49"	110 lbs.

Stacked Drawer Units

MODEL	DRAWERS	HEIGHT	WIDTH	DEPTH	WEIGHT
326-3	2 Stacked	12¼"	12¼"	49"	48 lbs.
327-3	3 Stacked	17¾"	12¼"	49"	71 lbs.
328-3	4 Stacked	23½"	12¼"	49"	92 lbs.

BED RAT[®] SLIDING PLATFORM

Extend your van's workspace and bring heavy loads to you, instead of bending in to get them, with this sliding platform. Sized to fit your work needs, BED RAT[®] Sliding Platforms are available for both side and rear door openings.

70% EXTENSION

for easy access of stored materials and tools

750 LB. TOTAL CAPACITY

when weight is evenly distributed on the platform

10½" HIGH SIDE PANELS

are made from steel and help keep materials on the deck



Decking material is not included, ¾" plywood is recommended

FOR FULL-SIZE VAN SIDE DOOR

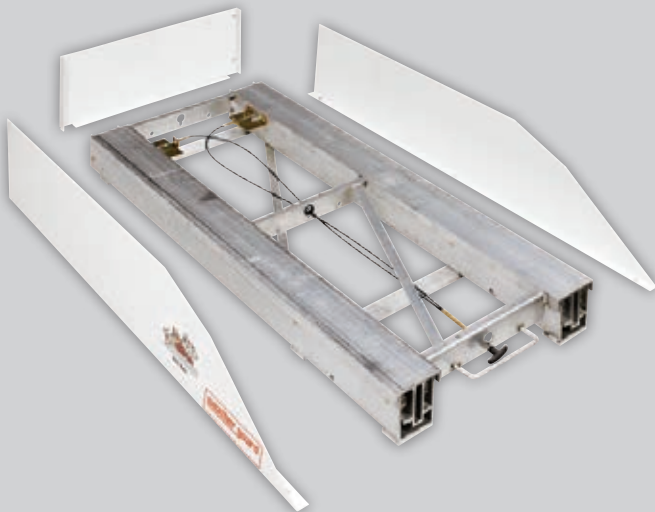

Model 3100

Perfect for curb side loading and unloading from the side door of Full-size vans.

FOR FULL-SIZE VAN & MINIVAN REAR DOOR

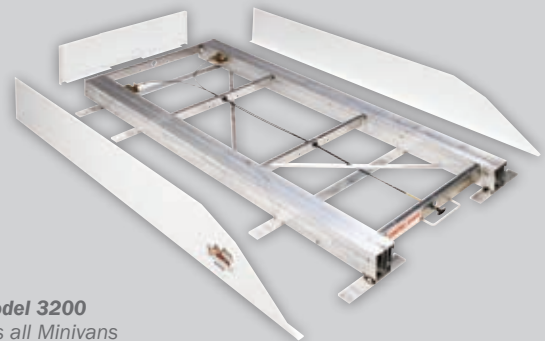

Model 3200

Fits all Minivans and Full-size vans.

FOR LONG WHEEL BASE FULL-SIZE VAN REAR DOOR



Model 3400

Fits all Full-size long wheel base and extended vans

BED RAT[®] Sliding Platforms

MODEL	HEIGHT	WIDTH	DEPTH	WEIGHT
3100	4¾"	22"-44¾"	54"	97 lbs.
3200	4¾"	44¾"	68"	123 lbs.
3400	4¾"	44¾"	90"	155 lbs.

The BED RAT[®] can fit a 22" - 44 ¾" deck

SPECIALTY STORAGE

EZGlide²™ DROP-DOWN LADDER RACK



TWO FINGER OPERATION



EASY REMOVAL



SAFE OPERATION



LADDER LOCK BRACKET



EASIEST TO OPERATE

50% less effort to operate than competitor drop-down ladder racks, reducing strain on the operator

LIGHTEST WEIGHT

Drop-down ladder rack available

- Maximize fuel economy
- Maximize carrying capacity

MOST VERSATILE

- Up to 40' extension ladders
- 5' - 10' stepladders
- Conduit carriers

STOW AND SECURE

Interlocking ladder supports ensure ladders stay in place when stowed

INCREASED PRODUCTIVITY

Get ladders off your van on the job faster and reduce worker fatigue and injuries

STEP 1

CHOOSE A MOUNTING KIT

(Mounting kits are not needed for Chevy Express, GMC Savana or Ford E-Series vans, go to Step 2.)

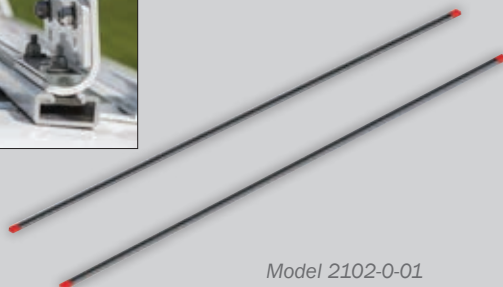
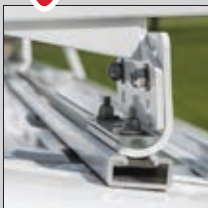

Model 2102-0-01

Mounting Kits *all mounting hardware included*

MODEL	DETAILS	WEIGHT
2102-0-01	Ford Transit 148" and extended wheelbase Mounting Channel Kit	15 lbs.
2130-0-01	Ford Transit 130" wheelbase Mounting Channel Kit	12 lbs.
2113-0-01	Mounting Channel Kit for Sprinter, Nissan NV Low Roof	15 lbs.
2115-0-01	Mounting Channel Kit Ram ProMaster®	15 lbs.
2085-0-01	Compact Mounting Channel Kit for Ford Transit Connect, Chevy City Express, RAM ProMaster City™, Mercedes Metris, Nissan NV200, Nissan NV High Roof	15 lbs.
2505	Service Body Mounting Kit for Knapheide, Reading and similar service bodies	9 lbs.

STEP 2

SELECT A DROP-DOWN LADDER RACK ASSEMBLY

(Single-Side Only with Crossmembers)



Drop-Down Ladder Rack Assemblies Drop-down can mount on driver or passenger side. Rack fits 16' to 40' Extension, 5' to 10' Step and 3' to 8' Podium, evenly distributed on ladder rack. Carry ladders appropriate to the size of the vehicle.

MODEL	DETAILS	WEIGHT
2291-3-01	Extended Drop-Down for Mid-Roof/High-Roof Vans (Includes Two 70" Cross Members which can be set at 96" or 42" center to center)	77 lbs.
2271-3-01	Fixed Drop-Down for Full-Size Vans (Includes Two 70" Cross Members which can be set at 96" or 42" center to center)	77 lbs.
2261-3-01	Fixed Drop-Down for Compact Vans (Includes Two 60" Cross Members which can be set at 77" center to center)	83 lbs.

Always properly secure ladders to the ladder rack while driving. Transporting ladders longer than the vehicle is not recommended.

OPTIONAL

MAKE IT A DUAL DROP-DOWN LADDER RACK



Drop-Down Ladder Rack Assemblies Long ladder kits fit 16' to 40' Extension, 5' to 10' Step and 3' to 8' Podium, evenly distributed on ladder rack. Short ladder kits include a center cross member to carry shorter ladders on opposite side of rack.

MODEL	DETAILS	WEIGHT
2295-3-01	Extended Drop-Down Long Ladder Kit for Mid-Roof/High-Roof Vans with Cross Members set at 96" or 42" center to center	48 lbs.
2297-3-01	Extended Drop-Down Short Ladder Kit for Mid-Roof/High-Roof Vans (Includes 70" Cross Member which can be set at 42" center to center)	55 lbs.
2275-3-01	Fixed Drop-Down Long Ladder Kit for Full Size Vans with Cross Members set at 96" or 42" center to center	51 lbs.
2277-3-01	Fixed Drop-Down Short Ladder Kit for Full Size Vans (Includes 70" Cross Member which can be set at 42" center to center)	57 lbs.
2265-3-01	Fixed Drop-Down Long Ladder Kit for Compact Vans with Cross Members set at 77" center to center	58 lbs.
2267-3-01	Fixed Drop-Down Short Ladder Kit for Compact Vans (Includes 60" Cross Member which can be set at 42" center to center)	61 lbs.



Accessories

MODEL	DETAILS	WEIGHT
1 2501	Warning Light Holder	3 lbs.
2 2502	Mirror Holder (not for use with 255 Driver's Side Drop-Down kit)	3 lbs.
3 2503	Velcro Straps	1 lb.
4 2504	Mirror	2 lbs.
5 2254D-3-01	NEW! Quick Clamp Add-On Kit - Driver Side	13 lbs
6 2254P-3-01	NEW! Quick Clamp Add-On Kit - Passenger Side	13 lbs

QUICK CLAMP ALUMINUM RACKS

NEW AND IMPROVED

Introducing the new and improved Quick Clamp Aluminum Racks engineered to fit Full Size Vans. Mounting Kits are not needed for Ford E-Series, Chevy Express, and GMC Savana. Not recommended for vans with roof heights above 84 inches.

WEATHER GUARD® VAN SOLUTIONS TRADEMARKED RED TIPS
show the world that you work with the highest quality equipment available

LONG LASTING DESIGN
utilizing a 70" extruded aluminum rail and stainless steel hardware. Designed for use with WEATHER GUARD® mounting channel kits or gutter clamps. Gas springs with internal brass bushings prevent strip-out

LADDER HOOKS
on the front end of the side rails have been extended and angled outward for easier loading of ladders in tight places

ADJUSTABLE SWAY BRACES
for easy ladder change out

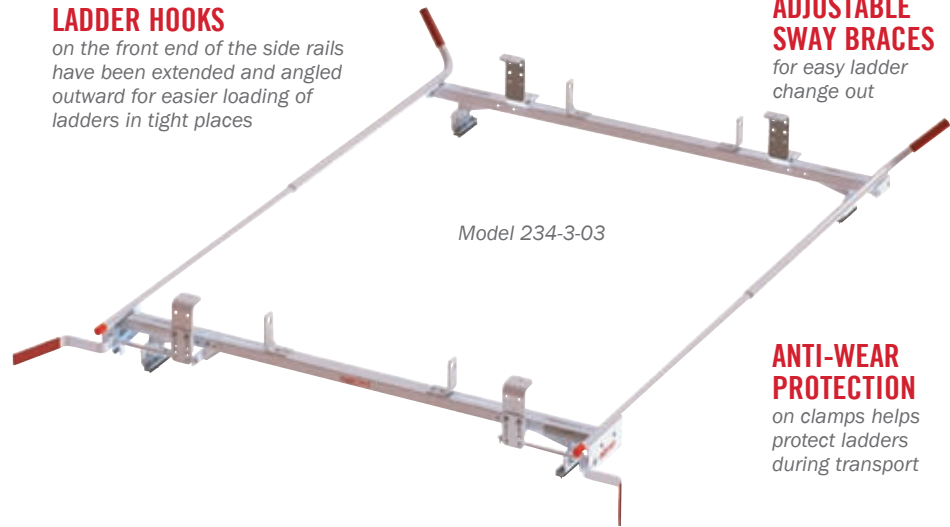

ANTI-WEAR PROTECTION
on clamps helps protect ladders during transport

STEP 1

CHOOSE A MOUNTING KIT (Mounting kits are not needed for Chevy Express, GMC Savana or Ford E-Series vans, go to Step 2.)

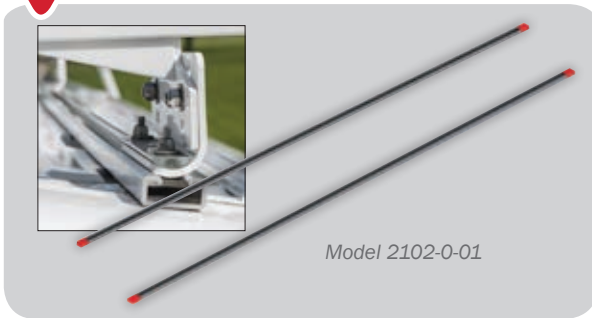

Model 2102-0-01

Mounting Kits all mounting hardware included

MODEL	DETAILS	WEIGHT
2102-0-01	Ford Transit 148" and extended wheelbase Mounting Channel Kit	15 lbs.
2130-0-01	Ford Transit 130" wheelbase Mounting Channel Kit	12 lbs.
2113-0-01	Mounting Channel Kit for Sprinter, Nissan NV Low Roof	15 lbs.
2115-0-01	Mounting Channel Kit Ram ProMaster®	15 lbs.

STEP 2

CHOOSE QUICK CLAMP RACK AND ACCESSORY CROSS MEMBERS (IF DESIRED)

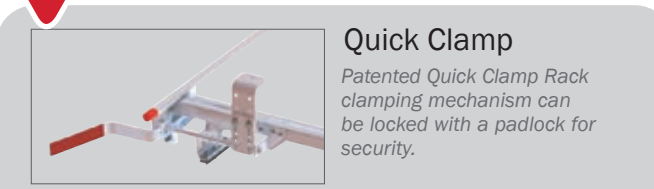

Quick Clamp
Patented Quick Clamp Rack clamping mechanism can be locked with a padlock for security.



Works with model 234-3-03 and 236-3-03 Quick Clamp Racks to accommodate short ladders and provide additional support.

Quick Clamp Rack for Full Size Vans



MODEL	DETAILS	WEIGHT
234-3-03	70" Dual Quick Clamp Rack	58 lbs.
236-3-03	70" Single Quick Clamp Rack - Curb Side Only	48 lbs.

Quick Clamp Rack - Full Size Accessory Cross Member

MODEL	DETAILS	WEIGHT
233-3-03	70" Quick Clamp Accessory Cross Member	19 lbs.

WEATHER GUARD® EXCLUSIVE!





Introducing the new and improved Quick Clamp Aluminum Racks engineered to fit **Compact Vans**.

LONG LASTING DESIGN

utilizing a 60" extruded aluminum rail and stainless steel hardware. Designed for use with WEATHER GUARD® mounting channel kits.

LADDER HOOKS

on the front end of the side rail have been extended and angled outward for easier loading of ladders in tight places

ANTI-WEAR PROTECTION

on clamps helps protect ladders during transport



Model 224-3-03

ADJUSTABLE SWAY BRACES
for easy ladder change out

STEP 1

CHOOSE A MOUNTING KIT

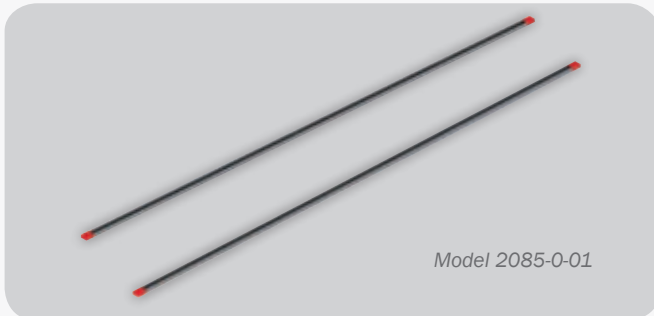

Model 2085-0-01

Mounting Kits *all mounting hardware included*

MODEL	DETAILS	WEIGHT
2085-0-01	Compact Mounting Channel Kit for Ford Transit Connect, Chevy City Express, RAM ProMaster City™, Mercedes Metris, Nissan NV200	15 lbs.

Mounting channel kits attach to factory mounting points. No drilling required.

STEP 2

CHOOSE QUICK CLAMP RACKS

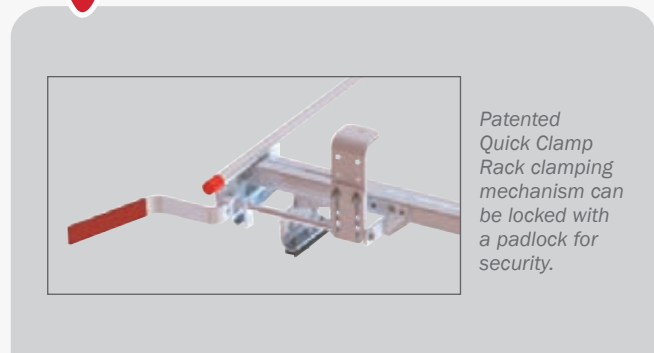

Patented Quick Clamp Rack clamping mechanism can be locked with a padlock for security.

Quick Clamp Racks



MODEL	DETAILS	WEIGHT
223-3-03	60" Single Quick Clamp Rack - Curb Side Only	44 lbs.
224-3-03	60" Dual Quick Clamp Rack	54 lbs.

OPTIONAL

ACCESSORY CROSS MEMBER



Works with models 223-3-03 and 224-3-03 Quick Clamp Racks to accommodate short ladders and provide additional support.

Accessory Cross Member

MODEL	DETAILS	WEIGHT
225-3-03	60" Quick Clamp Accessory Cross Member	16 lbs.

Mounting Assembly



Mounting rail fits to OEM van mounting points effectively distributing load.

ALL-PURPOSE RACKS

Versatile and rugged, our All-Purpose Racks create a space for all the long equipment you need to carry. Available in aluminum or steel, WEATHER GUARD® Roof Racks offer a number of different mounting and accessory options.

STEP 1

CHOOSE A MOUNTING KIT (Mounting kits are not needed for Chevy Express, GMC Savana or Ford E-Series vans, go to Step 2.)

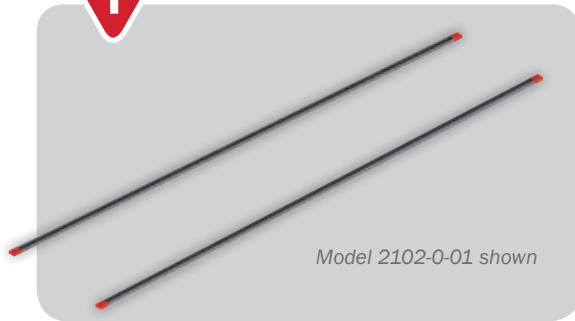

Mounting Kits all mounting hardware included

MODEL	DETAILS	WEIGHT
2102-0-01	Ford Transit 148" and extended wheelbase Mounting Channel Kit	15 lbs.
2130-0-01	Ford Transit 130" wheelbase Mounting Channel Kit	12 lbs.
2113-0-01	Mounting Channel Kit for Sprinter, Nissan NV	15 lbs.
2115-0-01	Mounting Channel Kit for Ram ProMaster®	15 lbs.
2085-0-01	Compact Mounting Channel Kit for Ford Transit Connect, Chevy City Express, RAM ProMaster City™, Mercedes Metris, Nissan NV200, Nissan NV High Roof)	15 lbs.

STEP 2

CHOOSE ALL PURPOSE RACK AND ACCESSORY CROSS MEMBERS

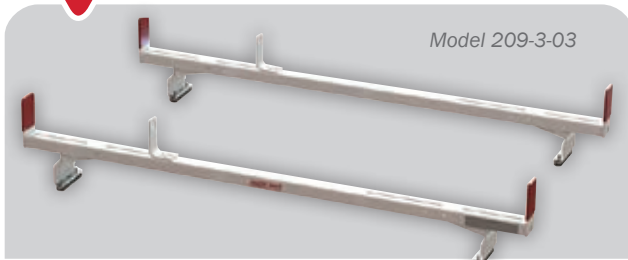

Powder Coated Aluminum Rack for Full-Size Vans

MODEL	DETAILS	WEIGHT
209-3-03	70" All Purpose Rack	35 lbs.
2097-3-03	70" All Purpose Accessory Cross Member	43 lbs.
2097-3	Accessory Cross Member	20 lbs.

Ford E-Series, Chevy Express, & GMC Savana do not require a mounting channel kit

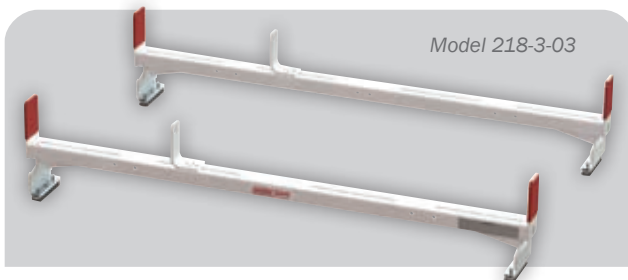

Powder Coated Aluminum Rack for Compact

MODEL	DETAILS	WEIGHT
218-3-03	60" All Purpose Aluminum Van Rack	31 lbs.
222-3-03	60" All Purpose Accessory Cross Member	17 lbs.

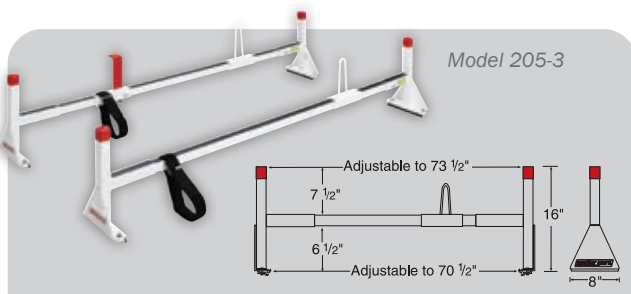

Powder Coated Heavy Duty Steel Rack for Chevy Express, GMC Savana, Ford E-Series

MODEL (white)	DETAILS	WEIGHT
205-3	2 Cross Member Rack	42 lbs.
216-3	3 Cross Member Rack	62 lbs.
2056-3	Accessory Cross Member	23 lbs.

Also available in black: models 205-5, 216-5, 2056-5.

SAFARI RACK FOR FULL-SIZE VANS

Excellent for hauling all types of materials, the Safari Rack easily accommodates 4-foot wide loads and distributes the weight evenly over eight cross members to protect the roof of the van. ***Fits GMC Savana, Chevy Express, Ford E-Series only.***

FRONT & REAR CROSS MEMBERS

extend over the ends of the van for protection when loading ladders and other long materials

ANTI-WEAR PROTECTION

on cross members helps protect ladders and building materials during transport

CROSS MEMBERS

are constructed of 13-gauge, 1¼" x 1¼" square steel tubing and spread the load evenly to protect long, fragile materials

STAINLESS STEEL MOUNTING BRACKETS

are extra wide for superior attachment strength to the gutter



AIR FOIL

eliminates wind noise and mounts to the front of the cross member

VELCRO STRAPS

assist in securing your ladder for transport

CENTER LEG



TIE DOWNS



MODEL	HEIGHT	WIDTH	WEIGHT
210-3	150¾"	64"	205 lbs.

For GMC Savana, Chevy Express, Ford E-Series vans only. Length from front to rear cross member is 140"

SLIDING LADDER RACK

Our Sliding Ladder Rack provides quick and easy ladder storage inside your van, enclosed trailer, or cube van. Rugged and durable, this rack fits 8-foot step, extension, or multi-position ladders when mounted to the roof.

UNIVERSAL MOUNTING BRACKET

adjusts to different vehicles

SAFETY CABLE

secures ladder in place

3-PIECE RAIL ASSEMBLY

accepts up to an 8' ladder

ROOF MOUNTING BRACKET

is provided for horizontal installation



MOUNTING BRACKETS



ADJUSTABLE CRADLE

accommodates different types of ladders

TENSION CORD GUIDE

prevents cords from tangling

MODEL	WEIGHT
250	27 lbs.

CONDUIT CARRIERS

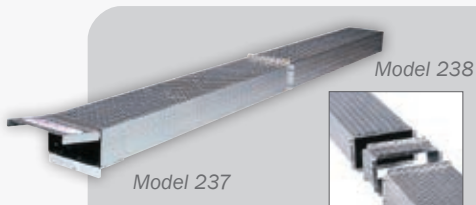

Model 238

Model 237

Keep your conduit safe, secure, and clean with our lightweight and durable Conduit Carrier.



Model 239

PVC not included. Separately purchase a section of standard 6" PVC (9ASTM D2665) plastic drain pipe. Coordinate the length of the PVC with the length of conduit you'll be carrying.

Aluminum Conduit Carrier

MODEL	DETAILS	LENGTH	WIDTH	HEIGHT	WEIGHT
237	Conduit Carrier	121½"	11"	6"	40 lbs.
238	Extension	6"	11"	6"	4 lbs.

(Mounts to EZGLIDE2™ with third Cross Member.)

Make-Your-Own Conduit Carrier

MODEL	WEIGHT
239	4 lbs.

ROOF RACK FITTING GUIDE



Vehicle Type	FULL-SIZE VANS									COMPACT VANS						OTHER	
	Low-roof					Mid-/High-roof				Ford Transit Connect	Ford Transit Connect	Ram Promaster City™	Chevrolet City Express	Nissan NV200	Mercedes Metris	Service Bodies	Box Trucks/Trailers
	Ford Transit	Ford E-Series	Chevrolet Express	GMC Savana	Nissan NV	Ford Transit	Ram Promaster®	Mercedes Sprinter	Nissan NV								
Model Years	2015-2016	1992-2013	1996-2016	1996-2016	2011-2016	2015-2016	2014-2016	2007-2016	2011-2016	2010-2013	2014-2016	2015-2016	2015-2016	2014-2016	2016		
Mounting Kits		N/R	N/R	N/R													
2085-0-01										X	X	X	X	X	X		
2102-0-01	X ²					X ²											
2130-0-01	X ²				X	X ²		X	X								X
2115-0-01							X										
2505																	X
EZGLIDE2™ DROP-DOWN LADDER RACKS																	
2261-3-01										X	X	X	X	X	X		
2265-3-01										X	X	X	X	X	X		
2267-3-01										X	X	X	X	X	X		
2271-3-01	X	X ¹	X ¹	X ¹	X												
2275-3-01	X	X ¹	X ¹	X ¹	X												
2277-3-01	X	X ¹	X ¹	X ¹	X												
2291-3-01						X	X	X	X							X	X
2295-3-01						X	X	X	X							X	X
2297-3-01						X	X	X	X							X	X
ALUMINUM QUICK CLAMP RACKS																	
223-3-03										X	X	X	X	X	X		
224-3-03										X	X	X	X	X	X		
225-3-03										X	X	X	X	X	X		
233-3-03	X	X ¹	X ¹	X ¹	X	X	X	X	X								
234-3-03	X	X ¹	X ¹	X ¹	X	X	X	X	X								
236-3-03	X	X ¹	X ¹	X ¹	X	X	X	X	X								
ALUMINUM ALL-PURPOSE RACKS																	
209-3-03	X	X ¹	X ¹	X ¹	X	X	X	X	X								
2097-3-03	X	X ¹	X ¹	X ¹	X	X	X	X	X								
218-3-03										X	X	X	X	X	X		
222-3-03										X	X	X	X	X	X		
229-3-03		X ¹	X ¹	X ¹													
STEEL ALL-PURPOSE RACKS																	
205-3	205-5		X ¹	X ¹	X ¹												
216-3	216-5		X ¹	X ¹	X ¹												
2056-3	2056-5		X ¹	X ¹	X ¹												

1. Gutter-mounted van rack.

2. Use 2102-0-01 with 148" wheelbase and 148" wheelbase extended Transit vans and 2130-0-01 with 130" wheelbase vans.

Part Number Reference Guide

MODEL	DESCRIPTION	PAGE	MODEL	DESCRIPTION	PAGE	MODEL	DESCRIPTION	PAGE
205-3	All-Purpose Van Rack	30, 28	88047	Transit Connect Van Window Screen	18	96122-3-01	Sprinter Screen Bulkhead	8
205-5	All-Purpose Van Rack	30	88050	Ram ProMaster® Window Screen	18	96114-3-01	Chevy City Express Screen Bulkhead	8, 9
2056-3	Accessory Cross Member	30, 28	88051	Ram ProMaster® Window Screen	18	96301-3-01	Transit Low Roof, Window Bulkhead	7
2056-5	Accessory Cross Member	30	88052	Ram ProMaster® Window Screen	18	96301-3-01D	Deep set-back Bulkhead, Transit Low Roof, Window	7
2085-0-01	Mounting Channel Kit	10	88060	Ford Transit Low Roof Window Screen	18	96302-3-01	Transit Low Roof, Screen Bulkhead	7
210-3	Safari Rack	30, 29	88061	Ford Transit Low Roof Window Screen	18	96302-3-01D	Deep set-back Bulkhead, Transit Low Roof, Screen	7
2102-0-01	Mounting Channel Kit	24, 25, 26	88062	Ford Transit Mid/High Roof Window Screen	18	96311-3-01	Transit Mid Roof, Window Bulkhead	7
2113-0-01	Mounting Channel Kit	24, 25, 26	88063	Ford Transit Mid/High Roof Window Screen	18	96311-3-01D	Deep set-back Bulkhead, Transit Mid Roof, Window	7
216-3	All-Purpose Van Rack	30, 28	88064	Ford Transit Low Roof Window Screen	18	96312-3-01	Transit Mid Roof, Screen Bulkhead	7
216-5	All-Purpose Van Rack	30	8841	EZ-Cube Shelf Mat	13	96312-3-01D	Deep set-back Bulkhead, Transit Mid Roof, Screen	7
218-3-01	All-Purpose Van Rack Mini	30, 28	8866	Fire Extinguisher	6, 11	96321-3-01	Transit High Roof, Window Bulkhead	7
2130-0-01	Ford Transit 130" wheelbase Mounting Channel kit	24, 26	8867-3-01	42" Work Top	17	96321-3-01D	Deep set-back Bulkhead, Transit High Roof, Window	7
220-3	All-Purpose Van Rack Mini	30	8873-3-01	Extension Cord Brackets	11	96322-3-01	Transit High Roof, Screen Bulkhead	7
221-3	Accessory Cross Member	28	8875	Hard Hat Bracket	6, 11	96322-3-01D	Deep set-back Bulkhead, Transit High Roof, Screen	7
2261-3-01	Fixed Drop-Down for Compact Vans	25	8877-3	Practice Holder	6	96511-3-02	Transit Connect Window Bulkhead**	7
2265-3-01	Fixed Drop-Down Long Ladder Kit	25	8908-3	Special Order Parts Cabinet	15	96514-3-01	Chevy City Express Window Bulkhead	8, 9
2267-3-01	Fixed Drop-Down Short Ladder Kit	25	8931-3	Special Order Parts Cabinet	15	96102-3-01	Mesh Bulkhead Full Size Van	8
2271-3-01	Fixed Drop-Down for Full Sized Vans	25	89011	Universal Floor Mat	18	96121-3-01	Window Bulkhead Sprinter	8
2275-3-01	Fixed Drop-Down Long Ladder Kit	25	89015	GM Floor Mat	18	96141-3-01	Window Bulkhead Ram ProMaster®	9
2277-3-01	Fixed Drop-Down Short Ladder Kit	25	89017	Ford Floor Mat	18	96142-3-01	Screen Bulkhead Ram ProMaster®	9
229-3	All-Purpose Van Rack	30, 28	89020	Ram ProMaster® Floor Mat	18	96201-3-01	Bulkhead High Roof, Nissan NV	9
2291-3-01	Extended Drop-Down	25	89021	Ram ProMaster® Floor Mat	18	96901-3-01	Door Conversion Kit	6, 7, 8, 9
2295-3-01	Extended Drop-Down Long Ladder Kit	25	89022	Ram ProMaster® Floor Mat	18	96903-3-01	Solid Panel Kit	6, 7
2297-3-01	Extended Drop-Down Short Ladder Kit	25	89023	Ram ProMaster® Floor Mat	18	9703-3-02	Retainer Lip, 36"	11
237	Conduit Carrier	29	89024	Ford Transit Floor Mat	18	9704-3-02	Retainer Lip, 42"	11
238	Conduit Carrier Extension	29	89025	Ford Transit Floor Mat	18	9705-3-02	Retainer Lip, 52"	11
239	Conduit Carrier Kit	29	89026	Ford Transit Floor Mat	18	9706-3-02	Retainer Lip, 60"	11
250	Sliding Ladder Rack	29	9010-3-01	Floor Mat	18	9720-3-01	Nissan Floor Mounting Kit	11
2501	Accessory Warning Light Holder	25	9012-3-01	Cab Command Center	16	9730-3-01	Shelf Support, 36"	11
2502	Accessory Mirror Holder	25	9020-3-01	Locking Cabinet	17	9740-3-01	Shelf Support, 46"	11
2503	Accessory Velcro Straps	25	9021-3-01	Locking Cabinet With Shelf	17	9760-3-01	Shelf Support, 62"	11
2504	Accessory Mirror	25	9029-3-01	Open Cabinet With Bin	17	9822-3-01	Drawer Divider, Standard	15
2505	Service Body Mounting Kit	24	9036-3	Strong Box	18	9823	Shelf Divider, 13"	11
301-3	PACK RAT® Drawer Unit (30" x 12.5" x 24")	21	9040-3-01	Lockable Secure Storage Module	12	9824-3-01	Drawer Divider, Tall	15
303-3	PACK RAT® Drawer Unit (39.5" x 12.5" x 24")	21	9045-3-02	5 Drawer Secure Storage Module	12	9826	Shelf Divider, 16"	11
304-3	PACK RAT® Drawer Unit (30" x 9" x 48")	21	9123-3-01	Accessory Shelf, 36 in x 10.5" in	11	9832	Shelf Mat, 13"	11
305-3	PACK RAT® Drawer Unit (10.25" x 9" x 48")	21	9124-3-01	Accessory Shelf, 42 in x 10.5" in	11	9836	Small Bin Set (9 bins)	11
306-3	PACK RAT® Drawer Unit (20" x 9" x 48")	21	9125-3-01	Accessory Shelf, 52 in x 10.5" in	11	9854-7-01	Bin Set	11
307-3	PACK RAT® Drawer Unit (30" x 9" x 48")	21	9126-3-01	Accessory Shelf, 60 in x 10.5" in	11	9855-7-01	Medium Bin Set (6 bins)	11
308-3	PACK RAT® Drawer Unit (39.75" x 9" x 48")	21	9133-3-01	Shelf Narrow Short	11	9856-7-01	Large Bin Set (3 bins)	11
308-5	PACK RAT® Drawer Unit (39.75" x 9" x 48")	21	9134-3-01	Shelf Narrow Std	11	9858-7-01	Bin Set	11
310-3-01	PACK RAT® Drawer Unit (12.5" x 17.75" x 42")	21	9135-3-01	Shelf Narrow Xtd	11	9860-3-01	Catalog File Unit	17
3100	BED RAT® Sliding Platform	23	9136-3-01	Shelf Narrow Long	11	9861-3-01	Rack, Cable Reel (Floor Mount)	17
312-3	PACK RAT® Drawer Unit (30" x 9" x 24")	21	9143-3-01	Accessory Shelf, 36 in x 13.5" in	11	9862-3-01	Rack, Freon Tank 3 x 50"	17
314-3	ITEMIZER® Drawer Unit	22	9144-3-01	Accessory Shelf, 42 in x 13.5" in	11	9863-3-01	Rack, Freon Tank 2 x 30", 50"	17
316-3	ITEMIZER® Drawer Unit (2 lateral)	22	9145-3-01	Accessory Shelf, 52 in x 13.5" in	11	9864-3-01	Rack, Freon Tank 4 x 30"	17
317-3	ITEMIZER® Drawer Unit (3 lateral)	22	9146-3-01	Accessory Shelf, 60 in x 13.5" in	11	9866-3-01	Three Spool Cable Holder	17
318-3	ITEMIZER® Drawer Unit (4 lateral)	22	9163-3-01	Shelf Std Short	11	9871-3-01	Door Organizer (Trays)	16
3200	BED RAT® Sliding Platform	23	9164-3-01	Shelf Std Std	11	9872-3-01	Door Organizer (Open)	16
326-3	ITEMIZER® Drawer Unit (2 stacked)	22	9165-3-01	Shelf Std Xtd	11	9873-3-01	Door Organizer (Tool Holder)	16
327-3	ITEMIZER® Drawer Unit (3 stacked)	22	9166-3-01	Shelf Std Long	11	9874-7-01	Can Organizer	14
328-3	ITEMIZER® Drawer Unit (4 stacked)	22	9333-3-03	Heavy Duty Adj 2 Shelf Unit 42" x 34" x 13.5"	10	9878-7-01	Cleaning Station	14
334-3	PACK RAT® Drawer Unit (30" x 12.5" x 48")	21	9334-3-03	Heavy Duty Adj 2 Shelf Unit 42" x 34" x 13.5"	10	9879-7-01	Tool Organizer	6, 14
335-3	PACK RAT® Drawer Unit (10.25" x 12.5" x 48")	21	9335-3-03	Heavy Duty Adj 2 Shelf Unit 52" x 34" x 13.5"	10	9880-3-01	Literature Holder	11, 16
336-3	PACK RAT® Drawer Unit (20" x 12.5" x 48")	21	9336-3-03	Heavy Duty Adj 2 Shelf Unit 60" x 34" x 13.5"	10	9881-7-01	Caulk Tube Holder	14
337-3	PACK RAT® Drawer Unit (30" x 12.5" x 48")	21	9343-3-03	Heavy Duty Adj 3 Shelf Unit 36" x 44" x 16"	10	9882-7-01	Wire Spool Holder (End Mount)	14
338-3	PACK RAT® Drawer Unit (39.75" x 12.5" x 48")	21	9344-3-03	Heavy Duty Adj 3 Shelf Unit 42" x 44" x 16"	10	9883-7-01	Large Parts Bin	14
338-5	PACK RAT® Drawer Unit (39.75" x 12.5" x 48")	21	9345-3-03	Heavy Duty Adj 3 Shelf Unit 52" x 44" x 16"	10	9884-7-01	Medium Parts Bin	14
3400	BED RAT® Sliding Platform	23	9346-3-03	Heavy Duty Adj 3 Shelf Unit 60" x 44" x 16"	10	9885-7-01	5 Gallon Bucket Holder	14
70202	Quick Release Handle Kit	11	9353-3-03	Adjustable 3 Shelf Unit 36" x 44" x 13.5"	10	9886-7-01	30# Refrigerant Tank Holder	14
70206-XX	Replacement Lock Kit	12	9354-3-03	Adjustable 3 Shelf Unit 42" x 44" x 13.5"	10	9887-7-01	Ladder Holder	14
70210-XX	Key Alike Kit	12	9355-3-03	Adjustable 3 Shelf Unit 52" x 44" x 13.5"	10	9891-7-01	Large Hook (5" Dia)	14
70211-XX	Replacement Handle Kit	12	9356-3-03	Adjustable 3 Shelf Unit 60" x 44" x 13.5"	10	9892-7-01	2 Hook Holder (5" Dia)	14
7220	Mounting Bracket Kit for 14" knockdown shelves	15	9363-3-03	Heavy Duty Adj 4 Shelf Unit 36" x 35" x 16"	10	9893-7-01	3 Hook Cord Or Tool Holder	14
8118-3-01	Shelf Dividers (24")	11	9364-3-03	Heavy Duty Adj 4 Shelf Unit 42" x 35" x 16"	10	9906-3-02	Parts Cabinet 6 Bin	15
8230-3-01	30" Welded Stack Unit	13	9365-3-03	Heavy Duty Adj 4 Shelf Unit 52" x 35" x 16"	10	9909-3-02	Parts Cabinet 9 Bin	15
8313-3-01	Lockable Cabinet	17	9366-3-03	Heavy Duty Adj 4 Shelf Unit 60" x 35" x 16"	10	9912-3-02	2 Drawer Cabinet	17
8316-3-01	4 Drawer Cabinet	17	9373-3-03	Adjustable 4 Shelf Unit 36" x 60" x 13.5"	10	9914-3-02	4 Drawer Cabinet	17
8393-3-01	Special Order Shelf Unit (42" x 60" x 24")	11	9374-3-03	Adjustable 4 Shelf Unit 42" x 60" x 13.5"	10	9918-3-02	Parts Cabinet 18 Bin	15
8394-3-01	Special Order Shelf Unit (52" x 60" x 24")	11	9375-3-03	Adjustable 4 Shelf Unit 52" x 60" x 13.5"	10	9924-3-02	4 Drawer Tall Cabinet	15
8395-3-01	Special Order Shelf Unit (69" x 60" x 24")	11	9376-3-03	Adjustable 4 Shelf Unit 60" x 60" x 13.5"	10	9928-3-02	8 Drawer Tall Cabinet	15
8401-3-01	EZ-Cube Dividers	13	9381-3-03	Heavy Duty Shelf Unit for Secure Storage Modules, 42" x 44" x 16"	12	9950-7-02	Parts Box Cabinet	15
8502-3-01	EZ Shelf Door (42")	13	9391-3-03	Heavy Duty Shelf Unit for Secure Storage Modules, 42" x 60" x 16"	12	9951-9-01	Parts Box	15
8503-3-01	EZ Shelf Door (52")	13	9400-3-01	EZ-Cube Shelf Unit (42" x 43.25" x 13.75")	13	9953-7-01	Grab & Go Tool Cart	19
88021	Ford Van Window Screen	18	9444-3-01	42" Wheel Well Cabinet	13, 17	9984-3-01	Mechanics Grade Tool Cabinet	15
88022	Ford Van Window Screen	18	9452-3-01	EZ-Cube Shelf Unit (52" x 43.25" x 13.75")	13	9988-3-01	Mechanics Grade Tool Cabinet	15
88023	Ford Van Window Screen	18	9503-3-01	Shelf Door, 36"	11	9992-3-01	Top Shelf (42" w x 13" d)	23
88026	GM Van Window Screen	18	9504-3-01	Shelf Door, 42"	11	9993-3-01	Mounting bracket kit for 13" shelves	15
88027	GM Van Window Screen	18	9505-3-01	Shelf Door, 52"	11	9996-3-01	Mounting bracket kit for 16" shelves	18
88028	GM Van Window Screen	18	9506-3-01	Shelf Door, 60"	11	9993-3-01	Mounting bracket kit for 13" shelves	15
88040	Sprinter Van Window Screen	18	9603-3-02	Back Panel, 36"	11			
88041	Sprinter Van Window Screen	18	9604-3-02	Back Panel, 42"	11			
88042	RAM CV Van Window Screen	18	9605-3-02	Back Panel, 52"	11			
88043	RAM CV Van Window Screen	18	9606-3-02	Back Panel, 60"	11			
88044	RAM CV Van Window Screen	18	96101-3-01	Window Bulkhead Full Size Van	8			
88045	Transit Connect Van Window Screen	18	96111-3-02	Transit Connect Screen Bulkhead	7			
88046	Transit Connect Van Window Screen	18						



DISTRIBUTED BY:



LIMITED LIFETIME WARRANTY

Knaack LLC (the Manufacturer) warrants to the original purchaser, only, that WEATHER GUARD® van products (the "WEATHER GUARD Product") will be free from defects in material and workmanship from the date of purchase and continuing for the expected lifetime of the WEATHER GUARD Product. Please call our customer service department toll free at 1.800.456.7865 with any questions or comments.

DO NOT use these products for storing or transporting flammables, explosives, hazardous materials or waste, such as gasoline, solvents, gun powder, dynamite, gases or any tanks, torches or gas powered equipment. These products are intended and safe for storing and transporting small tools and other non-combustible, non-flammable materials. Any modification made to, or unintended use of, these products may create a dangerous condition causing death, serious bodily injury or property damage.

NOTICE

Any modification or unintended use of these products shall immediately void all manufacturers warranties. Manufacturer disclaims all liability for injuries to persons or property resulting from any modification to, or unintended use of these products.

Ford Transit Connect, Nissan NV, Mercedes Sprinter, and Dodge RAM CV are registered trademarks of their respective owners.

For information on the WEATHER GUARD® Van Solutions Limited Lifetime Warranty, visit www.weatherguard.com To order more WEATHER GUARD® Van Solutions OEM brochures, please call us at 800.456.7865



© 2017 Knaack, LLC. All rights reserved. The WernerCo logo is a trademark of Werner Co.